

THOMAS

CE 0341

WILLIAM

ASC Automatic Squelch control

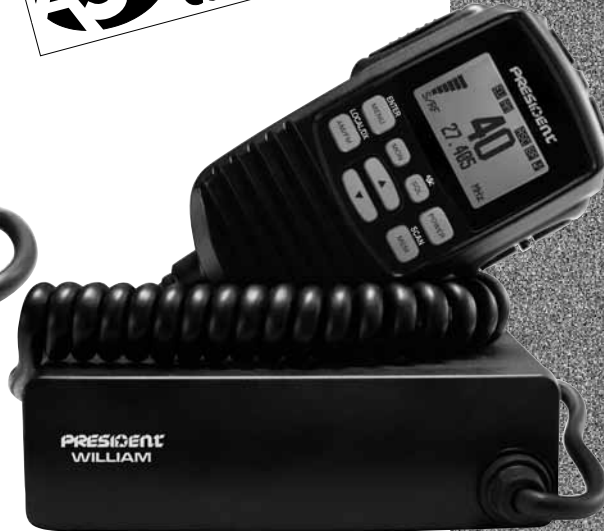

PRESIDENT

Owner's manual

Your **PRESIDENT THOMAS ASC** at a glance

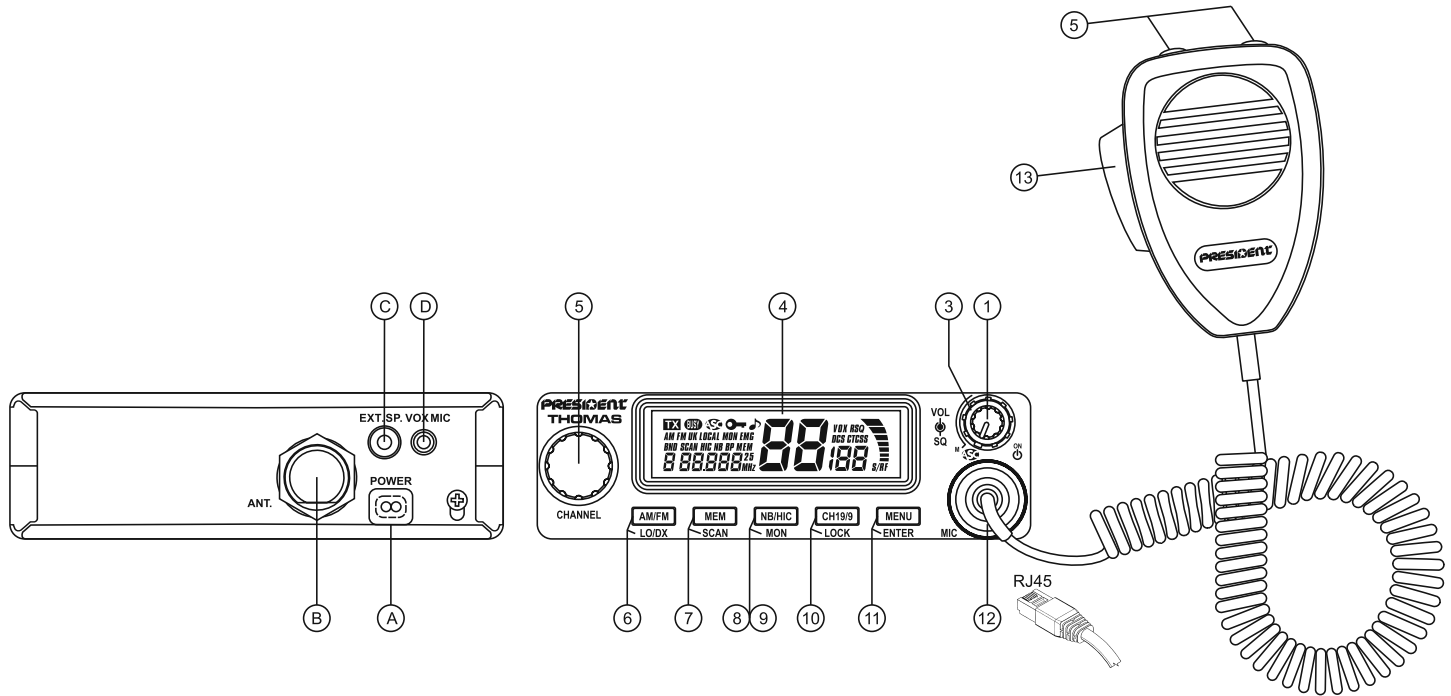

1 - **Power** and **Volume** knob (see page 9)

3 - **Squelch** knob (see page 10)

4 - **Display** (see page 10)

5 - **Channel selector** - rotary knob on the unit

▲ and ▼ key on the standard microphone
(see page 11)

6 - **AM/FM** and **LO/DX** key (see page 11 and 12)

7 - **MEM** and **SCAN** key (see page 12 and 13)

8/9 - **NB/HIC** and **MON** key (see page 14)

10 - **CH19/9** and **LOCK** key (see page 14 and 15)

11 - **MENU** and **ENTER** key (see page 15 and 16)

12 - **Microphone plug** - RJ45 (see page 16)

13 - **PTT** - Push To Talk (see page 16)

A - **Power supply** (see page 24)

B - **Antenna connector**

C - Jack for **external loudspeaker**

D - Jack for **optional vox mike**

Your **PRESIDENT WILLIAM ASC** at a glance

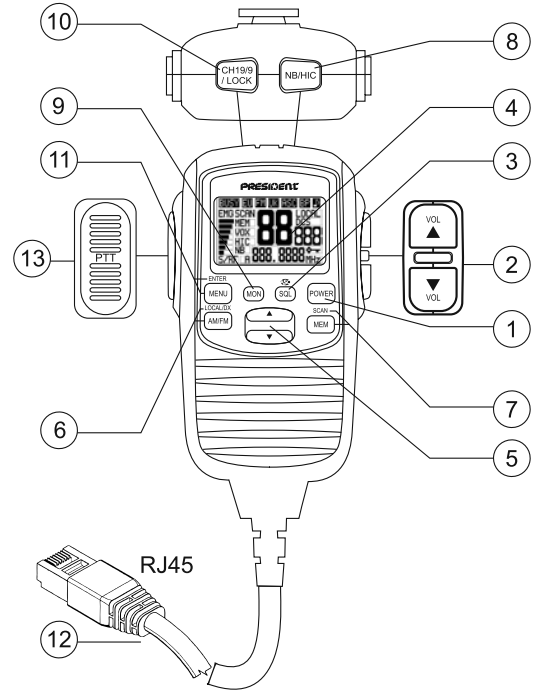
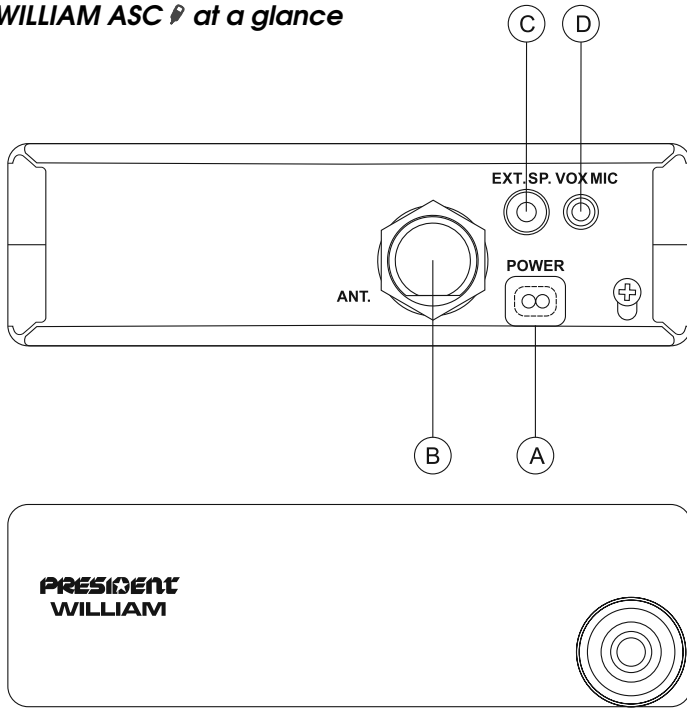

- 1 - **Power** key (see page 9)
- 2 - **Volume** ▲ and ▼ key (see page 9)
- 3 - **Squelch** key (see page 10)
- 4 - **Display** (see page 10)
- 5 - **Channel selector** ▲ and ▼ key (see page 11)
- 6 - **AM/FM** and **LO/DX** key (see page 11 and 12)

- 7 - **MEM** and **SCAN** key (see page 12 and 13)
- 8 - **NB/HIC** key (see page 14)
- 9 - **MON** key (see page 14)
- 10 - **CH19/9** and **LOCK** key (see page 14 and 15)
- 11 - **MENU** and **ENTER** key (see page 15 and 16)
- 12 - **Microphone plug** - RJ45 (see page 16)

- 13 - **PTT** - Push To Talk (see page 16)
- A - **Power supply** (see page 24)
- B - **Antenna connector**
- C - Jack for **external loudspeaker**
- D - Jack for **optional vox mike**

SUMMARY

INSTALLATION	6
HOW TO USE YOUR CB.....	9
TECHNICAL CHARACTERISTICS.....	25
TROUBLE SHOOTING.....	25
HOW TO TRANSMIT OR RECEIVE A MESSAGE	25
GLOSSARY	26
CERTIFICATE OF CONFORMITY	28
GENERAL WARRANTY CONDITIONS.....	29
FREQUENCY TABLES.....	29 ~ 31
EUROPEAN NORMS	33

WILLIAM remote microphone is optional on THOMAS.

This manual explains the features in two parts. “THOMAS ASC” and “WILLIAM ASC”. All the features for the WILLIAM ASC or for the THOMAS ASC using the optional remote SPK/MIC are preceded by the  icon and writed using this font style.

With the WILLIAM ASC or when you use the remote microphone accessory on THOMAS ASC, two items are added at the end of the Menu contents for adjustment of remote microphone features:

- DIMMER
- LCD CONTRAST

WARNING !

Before using, be careful never transmit without first having connected the antenna (connection "B" situated on the back panel of the equipment) or without having set the SWR (Standing Wave Ratio) ! Failure to do so may result in destruction of the power amplifier, which is not covered by the guarantee.

MULTI-NORMS TRANSCEIVER!

*See **Configuration** setting on page 23 and the **Norms - F** table on page 34 .*

The guarantee of this transceiver is valid only in the country of purchase.

Welcome to the world of the new generation of CB radios. The new PRESIDENT range gives you access to top performance CB equipment. With the use of up-to-date technology, which guarantees unprecedented quality, your PRESIDENT THOMAS ASC is a new step in personal communication and is the surest choice for the most demanding of professional CB radio users. To ensure that you make the most of all its capacities, we advise you to read carefully this manual before installing and using your PRESIDENT THOMAS ASC CB Radio.

A) INSTALLATION

1) WHERE AND HOW TO MOUNT YOUR MOBILE CB RADIO

- a) You should choose the most appropriate setting from a simple and practical point of view.
- b) Your CB radio should not interfere with the driver or the passengers.
- c) Remember to provide for the passing and protection of different wires (e.g. power, antenna, accessory cabling) so that they do not interfere in any way with the driving of the vehicle.

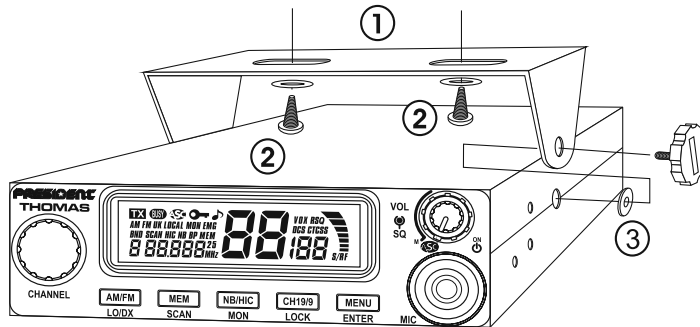

MOUNTING DIAGRAM

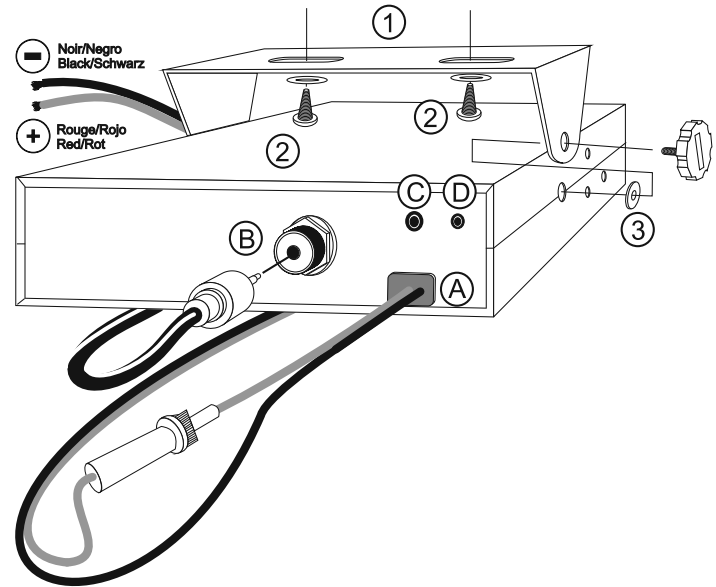

- d) To install your equipment, use the cradle (1) and the self-tapping screws (2) provided (drilling diameter 3.2 mm). Take care not to damage the vehicle's electrical system while drilling the dash board.
 - e) Do not forget to insert the rubber joints (3) between the CB and its support as these have a shock-absorbing effect which permits gentle orientation and tightening of the set.
 - f) Choose where to place the microphone support and remember that the microphone cord must stretch to the driver without interfering with the controls of the vehicle.
- **N.B. :** As the transceiver has a frontal microphone socket, it can be set into the dash board. In this case, you will need to add an external loud speaker to improve the sound quality of communications (connector EXT.SP situated on the back panel: C). Ask your dealer for advice on mounting your CB radio.

2) ANTENNA INSTALLATION

a) Choosing your antenna

- For CB radios, the longer is antenna, the better its results. Your dealer will be able to help you with your choice of antenna.

b) Mobile antenna

- Must be fixed to the vehicle where there is a maximum of metallic surface (ground plane), away from windscreen mountings.
- If you already have a radio-telephone antenna installed, the CB antenna should be higher than this.
- There are two types of antenna: pre-regulated which should be used on a good ground plane (e.g. car roof or lid of the boot), and adjustable which offers a much larger range and can be used on a smaller ground plane (see p. 8 § 5. Adjustment of SWR).
- For an antenna which must be fixed by drilling, you will need a good contact between the antenna and the ground plane. To obtain this, you should lightly scratch the surface where the screw and tightening star are to be placed.
- Be careful not to pinch or flatten the coaxial cable (as this runs the risk of break down and/or short-circuiting).
- Connect the antenna (B).

c) Fixed antenna

- A fixed antenna should be installed in as clear space as possible. If it is fixed to a mast, it will perhaps be necessary to stay it, according to the laws in force (you should seek professional advice). All PRESIDENT antennas and accessories are designed to give maximum efficiency to each CB radio within the range.

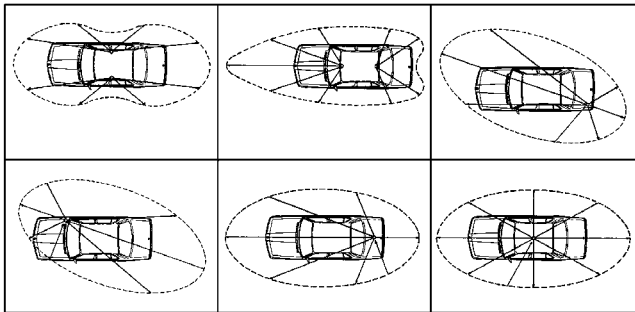

OUTPUT RADIUS PATTERNS

3) POWER CONNECTION

Your PRESIDENT THOMAS ASC is protected against an inversion of polarities. However, before switching it on, you are advised to check all the connections. Your equipment must be supplied with a continued current of 12 volts (A). Today, most cars and lorries are negative earth. You can check this by making sure that the negative terminal of the battery is connected either to the engine block or to the chassis. If this is not the case, you should consult your dealer.

WARNING: Lorries generally have two batteries and an electrical installation of 24 volts, in which case it will be necessary to insert a 24/12 volt converter (type CV 24/12 PRESIDENT) into the electrical circuit. The following connection steps should be carried out with the power cable disconnected from the set.

- Check that the battery is of 12 volts.
- Locate the positive and negative terminals of the battery (+ is red and - is black). Should it be necessary to lengthen the power cable, you should use the same or a superior type of cable.
- It is necessary to connect your CB to a permanent (+) and (-). We advise you to connect the power cable directly to the battery (as the connection of the CB cable to the wiring of the car-radio or other parts of the electrical circuit may, in some cases, increase the likelihood of interference).
- Connect the red wire (+) to the positive terminal of the battery and the black (-) wire to the negative terminal of the battery.
- Connect the power cable to your CB radio.

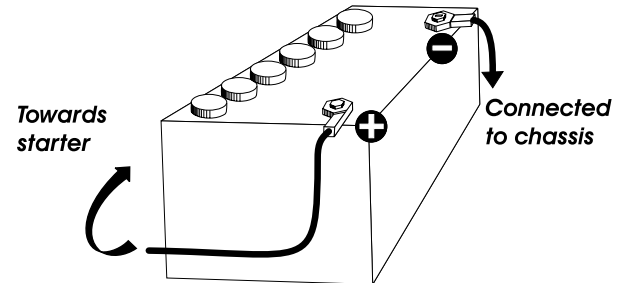

WARNING: Never replace the original fuse (2 A) by one of a different value.

4) BASIC OPERATIONS TO BE CARRIED OUT BEFORE USING YOUR SET FOR THE FIRST TIME (without transmitting and without using the «push-to-talk» switch on the microphone)

- a) Connect the microphone.
- b) Check the antenna connections.
- c) Turn the set on by pushing and holding the **POWER** knob (1).
- d) Turn the squelch knob (3) to minimum (**M** position).
- e) Adjust the volume to a comfortable level.
- f) Go to Channel **20** using either the «**UP**» «**DN**» key (5) on the microphone or the rotary knob (5).

5) ADJUSTMENT OF SWR (Standing wave ratio)

WARNING: This must be carried out when you use your CB radio for the first time (and whenever you re-position your antenna). The adjustment must be carried out in an obstacle-free area.

*** Adjustment with an external SWR meter (e.g. TOS-1 President)**

- a) To connect the SWR meter :
 - Connect the SWR meter between the CB radio and the antenna as close as possible to the CB (use a maximum of 40 cm cable, type President CA 2C).
- b) To adjust the SWR meter:
 - Set the CB to channel 20 in FM.
 - Put the switch on the SWR meter to position CAL or FWD.
 - Press the «push-to-talk» switch on the microphone to transmit.
 - Bring the index needle to ▼ by using the calibration key.
 - Change the switch to position SWR (reading of the SWR level). The reading on the Meter should be as near as possible to 1. If this is not the case, re-adjust your antenna to obtain a reading as close as possible to 1. (An SWR reading between 1 and 1.8 is acceptable).
 - It will be necessary to re-calibrate the SWR meter after each adjustment of the antenna.

WARNING: In order to avoid any losses and attenuations in cables used for connection between the radio and its accessories, PRESIDENT recommends to use a cable with a length inferior to 3m.

Your CB is now ready for use.

B) HOW TO USE YOUR CB

1) POWER ON/OFF CONTROL

Push and hold **POWER** knob (1).

 Push and hold **POWER** key (1) of the remote SPK/MIC.

Power on/off is switched alternately.

2) VOLUME CONTROL

Rotate **VOL** knob (1).

 Push **VOL** ▲ / ▼ key (2) of the remote SPK/MIC.

Main unit volume is 43 steps from 0 to 42. But remote SPK/MIC volume is 8 steps from 0 to 7.

See Loudspeaker Mute page 24.

THOMAS ASC

WILLIAM ASC

Current volume and configuration is displayed after 3 seconds



Wake up display when remote SPK/MIC is connected



Rotate VOL knob

} synch



Rotate VOL knob

} synch



3) ASC (Automatic Squelch Control) / SQUELCH

Suppresses undesirable background noises when there is no communication. Squelch does not affect neither sound nor transmission power, but allows a considerable improvement in listening comfort.

a) ASC: AUTOMATIC SQUELCH CONTROL

Worldwide patent, a PRESIDENT exclusivity.
Turn the **SQ** knob (3) anti-clockwise into **ASC** position.

Press **SQL** key (3) on the remote SPK/MIC during 1,5 second

“**ASC**” appears on the display. No repetitive manual adjustment and a permanent improvement between the sensitivity and the listening comfort when ASC is active. This function can be disconnected by turning the knob clockwise. In this case the squelch adjustment becomes manual again. “**ASC**” disappears from the display.

b) MANUAL SQUELCH

Turn the **SQ** knob (3) clockwise to the exact point where all background noise disappears. This adjustment should be done with precision as, if set to maximum (fully clockwise), only the strongest signals will be received. With this setting, **RSQ** (remote squelch function of the remote SPK/MIC) is stopped.

c) MANUAL SQUELCH OF REMOTE SPK/MIC

Press **SQL** key (3) on the remote SPK/MIC. The remote squelch level is selectable (3 levels). Push **▲ / ▼** key (5) to select the level. Push **ENTER (MENU)** key (11) to store the setting. “**RSQ**” is displayed.

59LαF ↔ 59L - 1 ↔ 59L - 2 ↔ 59L - 3

SQL - 1 ↔ SQL - 2 ↔ SQL - 3

With this setting, manual squelch function of the main unit is stopped. When the **SQL** level is **OFF**, remote squelch is inactive, “**RSQ**” disappears and manual squelch knob form the unit (3) is active.

4) S/R/F METER

S/R/F meters indicate the receiving signal strength in **RX** mode.

THOMAS ASC

ASC work (Automatic Squelch Control)



SQ knob is active (Analog squelch)



SQ knob is inactive. Remote SQ (=digital threshold) is active (Remote squelch RSQ)



Middle strength signal



WILLIAM ASC





The **SRF meter** is used as RF power indicator in **TX** mode. **SRF meter** indicators are 8 steps from 1 (weak) to 7 (strong), and 0 (no signal).

5) CHANNEL SELECTOR: rotary knob and UP/DN keys of the microphone

These switches allow increasing or decreasing a channel. A «beep» sounds each time the channel changes if the **Key Beep** function is activated. See **KEY BEEP** function page 21.

Rotate Channel knob (5), or push and hold ▲ / ▼ key (5) of standard MIC.

Push or push and hold ▲ / ▼ key (5) of remote SPK/MIC.

6) MODE SELECTOR AM/FM ~ LO/DX

a) MODE SELECTOR AM/FM (short push)

This switch allows selecting the AM or FM modulation. Your modulation mode has to correspond to the one of your correspondent.

Amplitude modulation/AM: is for communications in areas where there are obstacles and over medium distances.

Frequency modulation/FM: for nearby communications in flat, open field.

Push **AM/FM** key (6).

Push AM/FM key (6) of the remote SPK/MIC.

AM/FM are switched alternately.

AM setting



FM setting

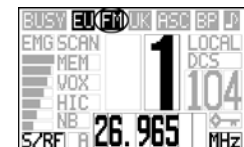

AM/FM 2nd function (only in U configuration)

Allows to alternate the frequency bands **CEPT** and **ENG** in the **U** configuration. When the **ENG** frequency band is selected, “**UK**” is displayed.

CEPT/ENG are switched alternately.

b) LO/DX (long push 1,5 s)

Allows the automatic adjustment of the **RF Gain** for close communication.

Push and hold **LO/DX** (AM/FM) key (6).

 Push and hold **LOCAL/DX** (AM/FM) key (6) of the remote SPK/MIC.

LO/DX is switched alternately.

7) MEM ~ SCAN

a) MEM (short push)

Those functions are memorized when memory command is done: Mode AM/FM ~ Channel number ~ CTCSS tone or DCS code.

MEM STORE (8 memories)

1. Select the channel to be memorized.
2. Push **MEM** key (7).
3. With the rotary knob (5) or the **▲ / ▼** key (5) of the standard microphone, select the memory to be stored (number from **1** to **8**).
4. Push and hold **MEM** key (7) to store the selected channel. Memorized data on memory number is displayed for 2 seconds.
5. After 2 seconds the unit returns to usual display.

MEM STORE (8 memories)

1. Select the channel to be memorized.
2. Push **MEM** key (7) of the remote SPK/MIC.
3. With the **▲ / ▼** key (5) of the remote SPK/MIC, select the memory to be stored (number from **1** to **8**).
4. Push and hold **MEM** key (7) of the remote SPK/MIC to store the selected channel. Memorized data on memory number is displayed for 2 seconds.
5. After 2 seconds the remote SPK/MIC returns to usual display.

Switching of CEPT and ENG in U configuration (ENG - ENGLAND)



LO/DX switching (Local)



MEMORY Store 1



MEMORY Store 3



MEMORY Store 4



MEM CALL

1. Push **MEM** key (7).
2. With the rotary knob (5) or the ▲ / ▼ key (5) of the standard microphone, select the memory to be called (number from 1 to 8).
3. Push **MEM** key (7) to select the memorized channel.

MEM CALL

1. Push **MEM** key (7) of the remote SPK/MIC in normal RX mode.
2. With the ▲ / ▼ key (5) of the remote SPK/MIC, select the memory to be called (number from 1 to 8).
3. Push **MEM** key (7) of the remote SPK/MIC to select the memorized channel.

MEM CLEAR

1. Clear of all memory is possible by turning on **POWER** (1) with **MEM** key (7) push.
2. All memories are cleared at configuration change (see page 23).

b)SCAN (long push 1,5 s)

There are 2 **SCAN** types :

ALL channels **SCAN** type (normal), “**SCAN**” icon is displayed.

MEM channels **SCAN** type, “**MEM**” icon is displayed and “**SCAN**” icon is blinking.

See page 18 for changing type.

Channel research: Allows activating the **SCAN** function (research of the channels) in an increasing way. The scanning stops as soon as there is a busy channel. The scanning automatically starts 3 seconds after the end of the reception signal and no key is activated during 3 s. The scanning starts again in an increasing way by turning the rotary knob to the right, or in a decreasing way by turning the rotary knob to the left.

Push and hold **SCAN** (MEM) key (7) to start the **SCAN**.

1. Push and hold **SCAN** (MEM) key (7) of the remote SPK/MIC to start the **SCAN**.

Both mode AM/FM are scanned alternately.

On the **MEM SCAN** type, both emergency channels are scanned with the memorized channels.

To disable the **SCAN** function press **PTT** key (13) or a new long press on **SCAN** (MEM) key (7).

THOMAS ASC

MEMORY Store 5



Display of normal SCAN mode



Display of memory SCAN mode



WILLIAM ASC



8) NB/HIC ~ MON

NB/HIC (short push)

NB Noise Blanker. These filters allow reducing back ground noises and some reception interferences. «**NB**» appears on the display when the NB filter is activated.

Hi-Cut Eliminates high frequency interferences. Has to be used in accordance with the reception conditions. «**HIC**» appears on the display when the **Hi-Cut** filter is activated.

Push the **NB/HIC** key (8) to select the filter alternately.

👉 Push **NB/HIC** (8) of the remote SPK/MIC to select the filter alternately.

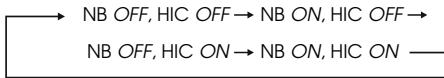

9) MON (long push 1,5 s)

The **MON** function deactivates the squelch function, it is used for "fast listening". It works with analogic squelch, ASC, RSQ squelch.

Push and hold **MON** (NB/HIC) key (8) to activate the **MON** function.

👉 Short push **MON** key (9) of the remote SPK/MIC to activate the **MON** function. It works with analogic squelch, ASC, RSQ squelch.

MON function on/off alternately. While this function is active "MON" icon blinks and "BUSY" icon lights.

10) CH19/9 ~ LOCK

a) CH19/9 (short push)

Push **CH19/9** key (10) to active instantly these emergency channels.

👉 Push **CH19/9** key (10) of the remote SPK/MIC to active instantly these emergency channels.

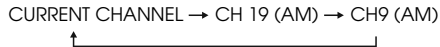

THOMAS ASC

Setting Filter NB + HIC



Setting transmission of MON



Channel transition of emergency calling

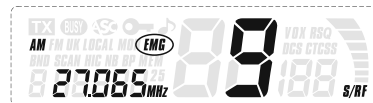
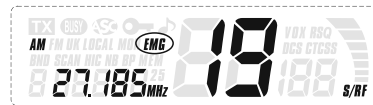

WILLIAM ASC



b) LOCK (long push 1,5 s)

Push and hold **LOCK** (CH19/9) key (**10**) to lock the unit and remote SPK/MIC.

Following functions are active even if the **LOCK** function is active:
PTT key (**13**), **SQ** knob (**3**), **VOL** and **POWER** knob (**1**).

 Push and hold **LOCK** (CH19/9) key (**10**) of the remote SPK/MIC to lock the remote SPK/MIC and the unit.

Following functions are active even if the **LOCK** function is active : **PTT** key (**13**), **SQL** key (**2**), **VOL** ▲ / ▼ key (**2**) and **POWER** key (**1**).



Key Lock on



11) MENU ~ ENTER

a) MENU (short push)

Push **MENU** key (**10**) to activate the **MENU** mode.

 Push **MENU** key (**10**) of the remote SPK/MIC to activate the **MENU** mode.

Press **MENU** key (**10**) once more, current setting is stored and menu changes from next setting (see table).

If no setting is done during 10 seconds, the unit exits from **MENU** mode.

N°	MENU Item	Effective area	Selectable item	Page
a	CTCSS/DCS setting	/CH	Off , CTCSS: 1 to 38, DCS: 1 to 104	17
b	SCAN TYPE setting	/CH	On/off	18
c	VOX SENSITIVITY LEVEL	/UNIT	off , 1 to 9	18
d	ANTI VOX LEVEL	/UNIT	0 to 9	19
e	VOX DELAY TIME	/UNIT	1 to 9 (0.2, 0.4, 0.6, 0.8, 1, 1.2, 1.5, 2, 3 seconds)	19
f	ROGER BEEP	/UNIT	on/off	20
g	KEY BEEP	/UNIT	on/off	21
h	BACK LIGHT COLOUR ⁽²⁾	/MAIN UNIT	Orange (o) / Green (G)	21
i	DIMMER ⁽¹⁾	/Remote SPK/MIC	off, LO, HI	22
j	LCD CONTRAST ⁽¹⁾	/Remote SPK/MIC	1 to 10	22

(1) DIMMER and LCD contrast setting appear on THOMAS only when optional remote SPK/MIC is connected. Thus if is not connected, selectable menu items are from a to h.

(2) Function doesn't work on the remote SPK/MIC. This function does not exist on WILLIAM ASC. Items change from g to i.

See the function features on the indicated page.

b) ENTER (long push 1,5 s)

Push and hold **ENTER** (MENU) key (10) to complete the setting and exit the **MENU** mode.

 Push and hold **ENTER** (MENU) key (10) of the remote SPK/MIC to complete the setting and exit the **MENU** mode.

12) MICRO PLUG RJ45

The plug is located on the front panel of the transceiver and makes the setting of the equipment into the dashboard easier.

Push 1, pull 2 to remove 

See cabling diagram page 33.

13) TRANSMISSION

a) PTT

Transmission key (13), press to transmit a message, **TX** is displayed and release to listen to an incoming communication.

 Transmission key (13) of the remote SPK/MIC, press to transmit a message, **TX** is displayed and release to listen to an incoming communication. To transmit, you can also use the **VOX** function.

b) VOX TRANSMISSION

The **VOX** function allows transmitting by speaking into the original microphone (or in the optional vox microphone) without pressing the **PTT** switch. When the **VOX** function is activate «**VOX**» is displayed. The use of an optional vox mike connected to the rear panel of the transceiver (D) disables the original microphone. Limit of continuous transmission is 5 minutes in VOX TX mode. If it is over, a radio mode changes to VOX transmission error condition automatically.

Following three parameters are selectable in menu mode: **VOX sensitivity** - **Anti VOX level** - **VOX delay time**.

 The **VOX** function mute the loudspeaker of the **WILLIAM** remote SPK/MIC.

See the **VOX** Setting parameters on page 18.

THOMAS ASC

WILLIAM ASC

PTT Transmission



VOX Transmission



Transmission Error



Transmission Error by ANTI VOX

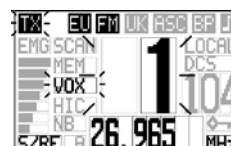

14) MENU FUNCTIONS

If no setting is done during 10 seconds, the unit exits from **MENU** mode.

a) CTCSS / DCS

CTCSS and DCS can be set on FM mode only.

CTCSS (Continuous Tone Coded Squelch System) and DCS (Digital Codes Squelch) are two tone squelch methods, they replace the manual squelch and simultaneously function similar to a selective call system. Squelch functions often depend on the field strength or are controlled via the signal-to-noise ratio. This means that they always depend on the varying conditions of reception. Each transmission on the selected channel and each interference carrier as well will open the squelch.

All radios belonging to a certain speech circuit have to be operated using the same CTCSS frequency or the same DCS. The squelch of the receiving radio only opens when a signal featuring the corresponding CTCSS/DCS is received.

The manual squelch and ASC are switched off. CTCSS and DCS still function when the signal is already very weak and has a considerable background noise. 38 CTCSS tones and 104 DCS codes are available.

Push the **MENU** key (11) **one** time. Current **CTCSS/DCS** setting is displayed. Rotate the Channel knob (5) or push ▲/▼ key (5) of the standard microphone to select the **CTCSS** tone or **DCS** code.

oF ↔ CTCSS (1 to 38) ↔ DCS (1 to 104)

oFF ↔ CTCSS (1 to 38) ↔ DCS (1 to 104)

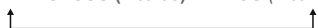

Push **MENU** key (11). Current setting is stored and menu setting changes to next.

Push and hold **ENTER** (MENU) key (11) to exit from the mode **MENU**.

Push the **MENU** key (11) of the remote SPK/MIC **one** time. Current **CTCSS/DCS** setting is displayed. Push ▲/▼ key (5) of the remote SPK/MIC to select the **CTCSS** tone or **DCS** code.

Push **MENU** key (11) of the remote SPK/MIC. Current setting is stored and menu setting changes to next.

Push and hold **ENTER** (MENU) key (11) of the remote SPK/MIC to store and exit from the mode **MENU**.

THOMAS ASC

WILLIAM ASC

DCS/CTCSS code select



b) SCAN TYPE

Push the **MENU** key (11) **two** times. Current **SCAN** type setting is displayed. Rotate the Channel knob (5) or push **▲/▼** key (5) of the standard microphone to select the **SCAN** type.

Push **MENU** key (11). Current setting is stored and menu setting changes to next.

Push and hold **ENTER** (MENU) key (11) to exit from the mode **MENU**.

- Push the **MENU** key (11) of the remote SPK/MIC **two** times. Current **SCAN** type setting is displayed. Push **▲ / ▼** key (5) of the remote SPK/MIC to select the **SCAN** type.

Push **MENU** key (11) of the remote SPK/MIC. Current setting is stored and menu setting changes to next.

Push and hold **ENTER** (MENU) key (11) of the remote SPK/MIC to store and exit from the mode **MENU**.

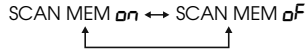

See **SCAN** function page 13.

c) VOX SENSITIVITY LEVEL - 5L

The VOX Sensitivity Level allows the adjustment of the microphone (original one or optional vox) for an optimum transmission quality. Adjustable level : **0F** (Off), from **1** (high level) to **9** (low level) .

Push the **MENU** key (11) **three** times. Current **VOX SENSITIVITY** setting is displayed. Rotate the Channel knob (5) or push **▲/▼** key (5) of the standard microphone to select the **VOX SENSITIVITY**.

Push **MENU** key (11). Current setting is stored and menu setting changes to next.

Push and hold **ENTER** (MENU) key (11) to exit from the mode **MENU**.

- Push the **MENU** key (11) of the remote SPK/MIC **three** times. Current **VOX SENSITIVITY** setting is displayed. Push **▲ / ▼** key (5) of the remote SPK/MIC to select the **VOX SENSITIVITY**.

Push **MENU** key (11) of the remote SPK/MIC. Current setting is stored and menu setting changes to next.

Push and hold **ENTER** (MENU) key (11) of the remote SPK/MIC to store and exit from the mode **MENU**.

When **VOX** function is active while a remote SPK/MIC is connected, speaker of remote SPK/MIC is always muted.

THOMAS ASC

SCAN type select



VOX Sensitive select



WILLIAM ASC



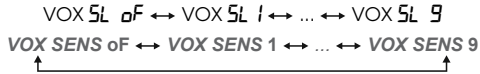

VOX transmission is limited until 5 minutes. If one transmission is over 5 minutes, a radio condition is changed to TX error condition.

d) ANTI VOX LEVEL - RL

ANTI VOX function checks speaker volume and inhibits VOX transmission. This is to prevent an easy loop from speaker sound to MIC. When anti VOX inhibition works, "VOX" icon blinks. The level is adjustable from 0 (Off) to 9 (low level).

Push the **MENU** key (11) **four** times. Current **ANTI VOX** setting is displayed. Rotate the Channel knob (5) or push ▲/▼ key (5) of the standard microphone to select the **ANTI VOX LEVEL**.

Push **MENU** key (11). Current setting is stored and menu setting changes to next.

Push and hold **ENTER** (MENU) key (11) to exit from the mode **MENU**.



Push the **MENU** key (11) of the remote SPK/MIC **four** times. Current **ANTI VOX LEVEL** setting is displayed. Push ▲/▼ key (5) of the remote SPK/MIC to select the **ANTI VOX LEVEL**.

Push **MENU** key (11) of the remote SPK/MIC. Current setting is stored and menu setting changes to next.

Push and hold **ENTER** (MENU) key (11) of the remote SPK/MIC to store and exit from the mode **MENU**.



e) VOX DELAY TIME - dt

VOX delay time is max wait time from the end of transmission request to actual end of transmission. If transmission request is detected in delay time, transmission will be done without pause.

Push the **MENU** key (11) **five** times. Current **VOX DELAY TIME** setting is displayed. Rotate the Channel knob (5) or push ▲/▼ key (5) of the standard microphone to select the **VOX DELAY TIME** (from 1 to 9).

ANTI VOX Level select



VOX Delay Time select

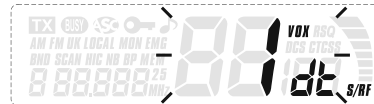

Push **MENU** key (11). Current setting is stored and menu setting changes to next.

Push and hold **ENTER** (MENU) key (11) to exit from the mode **MENU**.

 Push the **MENU** key (11) of the remote SPK/MIC five times. Current **VOX DELAY TIME** setting is displayed. Push **▲/▼** key (5) of the remote SPK/MIC to select the **VOX DELAY TIME** (form 1 to 9).

Push **MENU** key (11) of the remote SPK/MIC. Current setting is stored and menu setting changes to next.

Push and hold **ENTER** (MENU) key (11) of the remote SPK/MIC to store and exit from the mode **MENU**.



f) ROGER BEEP

ROGER BEEP is a short tone that is transmitted at the end of transmission. When the **ROGER BEEP** function is active “” is displayed.

Push the **MENU** key (11) six times. Current **ROGER BEEP** setting is displayed. Rotate the Channel knob (5) or push **▲/▼** key (5) of the standard microphone to select the **ROGER BEEP** setting (ON/OFF).

Push **MENU** key (11). Current setting is stored and menu setting changes to next.

Push and hold **ENTER** (MENU) key (11) to exit from the mode **MENU**.

 Push the **MENU** key (11) of the remote SPK/MIC six times. Current **ROGER BEEP** setting is displayed. Push **▲/▼** key (5) of the remote SPK/MIC to select the **ROGER BEEP** setting (ON/OFF).

Push **MENU** key (11) of the remote SPK/MIC. Current setting is stored and menu setting changes to next.

Push and hold **ENTER** (MENU) key (11) of the remote SPK/MIC to store and exit from the mode **MENU**.



VOX Delay Time select



ROGER BEEP setting



Transmitting roger beep can be heard through the speaker.

g) KEY BEEP

When the **KEY BEEP** function is active "BP" is displayed.

Push the **MENU** key (11) **seven** times. Current **KEY BEEP** setting is displayed. Rotate the Channel knob (5) or push ▲/▼ key (5) of the standard microphone to select the **KEY BEEP** setting (ON/OFF).

Push **MENU** key (11). Current setting is stored and menu setting changes to next.

Push and hold **ENTER** (MENU) key (11) to exit from the mode **MENU**.

- Push the **MENU** key (11) of the remote SPK/MIC **seven** times. Current **KEY BEEP** setting is displayed. Push ▲ / ▼ key (5) of the remote SPK/MIC to select the **KEY BEEP** setting (ON/OFF).

Push **MENU** key (11) of the remote SPK/MIC. Current setting is stored and menu setting changes to next.

Push and hold **ENTER** (MENU) key (11) of the remote SPK/MIC to store and exit from the mode **MENU**.

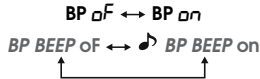

When **Key Beep** function is off, **Roger Beep** can't be heard through speaker but actual transmission is done automatically.

h) BACK LIGHT COLOUR (THOMAS only)

This function does not work with the display of the remote SPK/MIC.

Push the **MENU** key (11) **eight** times. Current **COLOUR** setting is displayed. Rotate the Channel knob (5) or push ▲/▼ key (5) of the standard microphone to select the **COLOUR** of the main unit display (GREEN/ORANGE).

Push **MENU** key (11). Current setting is stored and menu setting changes to next.

Push and hold **ENTER** (MENU) key (11) to exit from the mode **MENU**.

- Push the **MENU** key (11) of the remote SPK/MIC **eight** times. Current **COLOUR** setting is displayed. Push ▲ / ▼ key (5) of the remote SPK/MIC to select the **COLOUR** of the main unit display (GREEN/ORANGE).

THOMAS ASC

KEY BEEP setting



WILLIAM ASC



BACK LIGHT Color setting



Push **MENU** key (11) of the remote SPK/MIC. Current setting is stored and menu setting changes to next.

Push and hold **ENTER** (MENU) key (11) of the remote SPK/MIC to store and exit from the mode **MENU**.

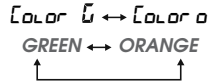

i) DIMMER (WILLIAM only)

This function does not work with the display of the main unit.

The **DIMMER** function changes the intensity of the back light of the remote SPK/MIC. OFF (no back light), LOW or HIGH intensity.

Push the **MENU** key (11) **nine** times. Current **DIMMER** setting is displayed. Rotate the Channel knob (5) to select the **DIMMER** of the remote SPK/MIC display.

Push **MENU** key (11). Current setting is stored and menu setting changes to next.

Push and hold **ENTER** (MENU) key (11) to exit from the mode **MENU**.



Push the **MENU** key (11) of the remote SPK/MIC **nine** times. Current **DIMMER** setting is displayed. Push ▲ / ▼ key (5) of the remote SPK/MIC to select the **DIMMER** of the remote SPK/MIC display.

Push **MENU** key (11) of the remote SPK/MIC. Current setting is stored and menu setting changes to next.

Push and hold **ENTER** (MENU) key (11) of the remote SPK/MIC to store and exit from the mode **MENU**.



j) LCD CONTRAST (WILLIAM only)

This function does not work with the display of the main unit.

The **CONTRAST** function changes the contrast (from 1 to 10) between the back light and the characters on the remote SPK/MIC.

Push the **MENU** key (11) **ten** times. Current **CONTRAST** setting is displayed. Rotate the Channel knob (5) to select the **CONTRAST** level of the remote SPK/MIC display.

THOMAS ASC

WILLIAM ASC

DIMMER setting

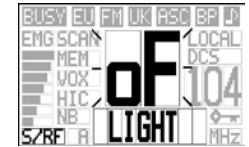

Push **MENU** key (11). Current setting is stored and menu setting changes to next.

Push and hold **ENTER** (MENU) key (11) to exit from the mode **MENU**.

- Push the **MENU** key (11) of the remote SPK/MIC **ten** times. Current **CONTRAST** setting is displayed. Push **▲/▼** key (5) of the remote SPK/MIC to select the **CONTRAST** level of the remote SPK/MIC display.

Push **MENU** key (11) of the remote SPK/MIC. Current setting is stored and menu setting changes to next.

Push and hold **ENTER** (MENU) key (11) of the remote SPK/MIC to store and exit from the mode **MENU**.



15) CONFIGURATION

(configuration: EU; PL; d; EC; U; In)

The frequency bands have to be chosen according to the country of use. Don't use any other configuration. Some countries need a user's licence.

See table page 35.

Proceeding

- Turn **POWER** (1) on with the **MENU** (11) key push. **Conf** and **current setting** are displayed.
- Push **MENU** (11) key. **Conf** and **current setting** start blinking.
- Rotate Channel knob (5) or push **▲/▼** key of standard microphone to select new setting.
- Push **MENU** (11) key. New setting is stored and **Conf** and **current setting** turn to light on LCD.

Proceeding

- Turn **POWER** (1) on with the **MENU** (11) key push of the remote SPK/MIC. **CONFIG** and **current setting** are displayed.
- Push **MENU** (11) key of the remote SPK/MIC. **CONFIG** and **current setting** start blinking.

THOMAS ASC

CONTRAST setting



WILLIAM ASC



CONFIGURATION setting - 1



CONFIGURATION setting - 2



CONFIGURATION setting - 3



3. Push ▲/▼ key (5) of the remote SPK/MIC to select new setting.
4. Push MENU (11) key of the remote SPK/MIC.
New setting is stored and CONFIG and current setting turn to light on LCD.

At this point, confirm the selection by switching off the transceiver and then switching it on again.

ConF EU → ConF PL → ConF d → ConF EC → ConF U → ConF In
 CONFIG EU → CONFIG PL → CONFIG d → CONFIG EC → CONFIG U → CONFIG In

See the frequency bands table pages 30 ~ 32 / configuration page 34

16) LOUDSPEAKER MUTE

The loudspeaker of the unit can be muted.
 Turn POWER (1) on with the NB/HIC (8) key push.

- ☞ Turn POWER (1) on with the MON (9) key push.
 Speaker on/off condition is changed alternately.

When the speaker is muted, rotate the VOLUME knob (1) or push the VOL ▲ / ▼ key (2) of the remote SPK/MIC always displays **Vol 00** on the THOMAS display. Volume is increased or decreased on the WILLIAM display.

17) TIME OUT TIMER

This function is used to limit the transmission time when PTT button is pressed, it stop transmission after times out, you have to release PTT button if you want to re-transmit. transmission is limited until 5 minutes. If one transmission is over 5 minutes, a radio condition is changed to TX error condition.

A) POWER SUPPLY (13.2 V)

B) ANTENNA CONNECTOR (SO-239)

C) JACK FOR EXTERNAL LOUDSPEAKER (8 Ω, Ø 3,5 mm)

D) JACK FOR OPTIONAL VOX MIKE (Ø 2,5 mm)

THOMAS ASC

CONFIGURATION setting - 4



WILLIAM ASC



VOLUME displays with loudspeaker muted



Rotate VOL knob



C) TECHNICAL CHARACTERISTICS

1) GENERAL

- Channels : 40
- Modulation modes : AM/FM
- Frequency ranges : from 26.965 MHz to 27.405 MHz
- CTCSS Tones : 38
- DCS codes : 104
- Antenna impedance : 50 ohms
- Power supply : 13.2 V
- Dimensions (in mm) : 125 (L) x 38 (H) x 103 (D)
- Weight : \approx 0.7 kg
- Accessories supplied : Electret microphone with support, mounting cradle, screws.
- Filter : ANL (Automatic Noise Limiter) built-in

2) TRANSMISSION

- Frequency allowance : +/- 200 Hz
- Carrier power : 4 W AM / 4 W FM
- Transmission interference : inferior to 4 nW (- 54 dBm)
- Audio response : 300 Hz to 3 KHz
- Emitted power in the adj. channel : inferior to 20 μ W
- Microphone sensitivity : 7 mV
- Drain : 1,8 A (with modulation)
- Modulated signal distortion : 2 %

3) RECEPTION

- Maxi. sensitivity at 20 dB sinad : AM / 0.5 μ V - 113 dBm
FM / 0.35 μ V - 116 dBm
- Frequency response : 300 Hz to 3 kHz
- Adjacent channel selectivity : 60 dB
- Maximum audio power : 2 W
- Squelch sensitivity : minimum 0.2 μ V - 120 dBm
maximum 1 mV - 47 dBm
- Frequency image rejection rate : 60 dB
- Intermediate frequency rej. rate : 70 dB
- Drain : 300 mA nominal / 750 mA maximum

D) TROUBLE SHOOTING

1) YOUR CB RADIO WILL NOT TRANSMIT OR YOUR TRANSMISSION IS OF POOR QUALITY

- Check that the antenna is correctly connected and that the SWR is properly adjusted.
- Check that the microphone is properly plugged in.
- Check that the programmed configuration is the correct one (see table page 34).

2) YOUR CB RADIO WILL NOT RECEIVE OR RECEPTION IS POOR

- Check that LOCAL DX (6) is off.
- Check that the squelch level is properly adjusted.
- Check that the programmed configuration is the correct one (see table page 34).
- Check that the volume is set to a comfortable listening level.
- Check that the antenna is correctly connected and that the SWR is properly adjusted.
- Check that you are using the same modulation mode as your correspondent.
- Check the use of a CTCSS tone or a DSC code.

3) YOUR CB WILL NOT LIGHT UP

- Check the power supply.
- Check the connection wiring.
- Check the fuse.

E) HOW TO TRANSMIT OR RECEIVE A MESSAGE

Now that you have read the manual, make sure that your CB Radio is ready for use (i.e. check that your antenna is connected).

Choose your channel (19, 27).

Choose your mode (AM/FM) which must be the same as that of your correspondent.

Press the «push-to-talk» switch and announce your message «Attention stations, transmission testing» which will allow you to check the clearness and the power of your signal. Release the switch and wait for a reply. You should receive a reply like, «Strong and clear».

If you use a calling channel (19, 27) and you have established communication

with someone, it is common practice to choose another available channel so as not to block the calling channel.

F) GLOSSARY

Below you will find some of the most frequently used CB radio expressions. Remember this is meant for fun and that you are by no means obliged to use them. In an emergency, you should be as clear as possible.

INTERNATIONAL PHONETIC ALPHABET

A Alpha	H Hotel	O Oscar	V Victor
B Bravo	I India	P Papa	W Whiskey
C Charlie	J Juliett	Q Quebec	X X-ray
D Delta	K Kilo	R Romeo	Y Yankee
E Echo	L Lima	S Sierra	Z Zulu
F Foxtrott	M Mike	T Tango	
G Golf	N November	U Uniform	

TECHNICAL VOCABULARY

AM	: Amplitude Modulation
CB	: Citizen's Band
CH	: Channel
CW	: Continuous Wave
DX	: Long Distance Liaison
DW	: Dual Watch
FM	: Frequency Modulation
GMT	: Greenwich Meantime
HF	: High Frequency
LF	: Low Frequency
LSB	: Lower Side Band
RX	: Receiver
SSB	: Single Side Band
SWR	: Standing Wave Ratio
SWL	: Short Wave Listening
SW	: Short Wave
TX	: CB Transceiver
UHF	: Ultra High Frequency
USB	: Upper Side Band
VHF	: Very High Frequency

CB LANGUAGE

Advertising	: Flashing lights of police car
Back off	: Slow down
Basement	: Channel 1
Base station	: A CB set in fixed location
Bear	: Policeman
Bear bite	: Speeding fine
Bear cage	: Police station
Big slab	: Motorway
Big 10-4	: Absolutely
Bleeding	: Signal from an adjacent channel interfering with the transmission
Blocking the channel	: Pressing the PTT switch without talking
Blue boys	: Police
Break	: Used to ask permission to join a conversation
Breaker	: A CBer wishing to join a channel
Clean and green	: Clear of police
Cleaner channel	: Channel with less interference
Coming in loud and proud	: Good reception
Doughnut	: Tyre
Down and gone	: Turning CB off
Down one	: Go to a lower channel
Do you copy?	: Understand?
DX	: Long distance
Eighty eights	: Love and kisses
Eye ball	: CBers meeting together
Good buddy	: Fellow CBer
Hammer	: Accelerator
Handle	: CBer's nickname
Harvey wall banger	: Dangerous driver
How am I hitting you?	: How are you receiving me?
Keying the mike	: Pressing the PTT switch without talking
Kojac with a kodak	: Police radar
Land line	: Telephone
Lunch box	: CB set
Man with a gun	: Police radar
Mayday	: SOS
Meat wagon	: Ambulance
Midnight shopper	: Thief
Modulation	: Conversation
Negative copy	: No reply
Over your shoulder	: Right behind you

Part your hair	: Behave yourself - police ahead
Pull your hammer back	: Slow down
Rat race	: Congested traffic
Rubberbander	: New CBer
Sail boat fuel	: Wind
Smokey dozing	: Parked police car
Smokey with a camera	: Police radar
Spaghetti bowl	: Interchange
Stinger	: Antenna
Turkey	: Dumb CBer
Up one	: Go up one channel
Wall to wall	: All over/everywhere
What am I putting to you?	: Please give me an S-meter reading.

CERTIFICATE OF CONFORMITY

We, GROUPE PRESIDENT ELECTRONICS, Route de Sète, BP 100 – 34540 Balaruc – FRANCE, declare, on our own responsibility that the CB radio-communication transceiver

Brand : **PRESIDENT**
Model : **THOMAS**

is in conformity with the essential requirements of the Directive 1999/5/CE (Article 3) adapted to the national law, as well as with the following European Standards:

EN 300 433-1 V1.3.1 (2011-07)
EN 300 433-2 V1.3.1 (2011-07)
EN 301 489-1 V1.8.1 (2010-1)
EN 301 489-13 V1.2.1 (2002-8)
EN 60215 (1996)

and is in conformity with Directive RoHS2: 2011/65/EU (2011/06/08).

Balaruc, the 2013-01-03



Jean-Gilbert MULLER
General Manager

CERTIFICATE OF CONFORMITY

We, GROUPE PRESIDENT ELECTRONICS, Route de Sète, BP 100 – 34540 Balaruc – FRANCE, declare, on our own responsibility that the CB radio-communication transceiver

Brand : **PRESIDENT**
Model : **WILLIAM**

is in conformity with the essential requirements of the Directive 1999/5/CE (Article 3) adapted to the national law, as well as with the following European Standards:

EN 300 433-1 V1.3.1 (2011-07)
EN 300 433-2 V1.3.1 (2011-07)
EN 301 489-1 V1.8.1 (2010-1)
EN 301 489-13 V1.2.1 (2002-8)
EN 60215 (1996)

and is in conformity with Directive RoHS2: 2011/65/EU (2011/06/08).

Balaruc, the 2013-01-03



Jean-Gilbert MULLER
General Manager

GENERAL WARRANTY CONDITIONS

This device is guaranteed **2 years** parts and labour in its country of purchase against any manufacturing defects validated by our technical department. *The After-sales Service of PRESIDENT reserves the right not to apply the warranty if a breakdown is caused by an antenna other than those distributed by PRESIDENT, and if said antenna is at the origin of the breakdown. An extension of **3 years** warranty is proposed systematically for the purchase and use of a PRESIDENT antenna, bringing the total duration of the warranty to **5 years**. In order to be valid, the warranty certificate must be returned within a period of 30 days after the purchase date to the After-sales Service of the company Groupe President Electronics, or any foreign subsidiary.

It is recommended to carefully read the following conditions and to respect them under penalty of losing their benefit.

- * To be valid the warranty certificate must be returned to us at the latest 1 month after the purchase.
- * Please duly complete the warranty certificate on the right hand side of the page, detach it (portion to be removed marked by dotted line) and send it back.
- * Any repair under warranty will be free and the return delivery costs will be borne by our company.
- * A purchase proof must be necessarily included with the device to be repaired.
- * The dates listed on the warranty certificate and proof of purchase must match.
- * Do not proceed with the installation of the device without reading the user manual.
- * No spare part will be sent nor exchanged by our services under warranty.

The warranty is only valid in the country of purchase.

Exclusions (are not covered):

- * Damages caused by accident, shock or inadequate packaging.
- * Power transistors, microphones, lights, fuses and the non respect of the installation and use of specifications (including but not limited to antenna used with too high power, final output power transistors (SWR), inversion of polarities, bad connections, overvoltage,...)
- * The warranty cannot be extended due to the non-availability of the device while it is being serviced at our technical services location, nor by a change of one or more components or spare parts.
- * Transceivers which have been modified. The warranty application is excluded in case of modification or poor maintenance done by a third party not approved by our company.

If you note malfunctions:

- * Check the power supply of your device and the quality of the fuse.
- * Check that the antenna, the microphone.... are correctly connected.
- * Check that the squelch level is properly adjusted; the programmed configuration is the correct one...

- * In case the device is not under warranty, the repair and return of the device will be charged.
- * All related documents must be preserved even after the end of the warranty period and if you resell your device, given to the new owner for the After-sales follow-up.
- * In case of real malfunction, please contact your dealer first; they will decide action to be taken.
- * In case of an intervention not covered by the warranty, an estimate will be established before any repair.

Thank you for your trust in the PRESIDENT quality and experience. We recommend that you read this manual carefully so that you are completely satisfied with your purchase. Do not forget to return the detachable warranty certificate on the right hand side of this page; it is very important for the identification of your device during a possible rendering of our services.

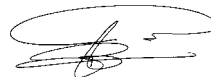

Technical Manager
and
Quality Manager



Date of purchase :

Type : radio CB THOMAS* / radio CB WILLIAM*

Serial N°:

** please cross out the option that do not apply*



NOT COVERED BY THE WARRANTY
WITHOUT THE DEALER STAMP

FREQUENCY TABLE for EU / EC / U (CEPT)

Channel	Frequency	Channel	Frequency
1	26,965 MHz	21	27,215 MHz
2	26,975 MHz	22	27,225 MHz
3	26,985 MHz	23	27,255 MHz
4	27,005 MHz	24	27,235 MHz
5	27,015 MHz	25	27,245 MHz
6	27,025 MHz	26	27,265 MHz
7	27,035 MHz	27	27,275 MHz
8	27,055 MHz	28	27,285 MHz
9	27,065 MHz	29	27,295 MHz
10	27,075 MHz	30	27,305 MHz
11	27,085 MHz	31	27,315 MHz
12	27,105 MHz	32	27,325 MHz
13	27,115 MHz	33	27,335 MHz
14	27,125 MHz	34	27,345 MHz
15	27,135 MHz	35	27,355 MHz
16	27,155 MHz	36	27,365 MHz
17	27,165 MHz	37	27,375 MHz
18	27,175 MHz	38	27,385 MHz
19	27,185 MHz	39	27,395 MHz
20	27,205 MHz	40	27,405 MHz

FREQUENCY TABLE for U (ENG)

Channel	Frequency	Channel	Frequency
1	27,60125 MHz	21	27,80125 MHz
2	27,61125 MHz	22	27,81125 MHz
3	27,62125 MHz	23	27,82125 MHz
4	27,63125 MHz	24	27,83125 MHz
5	27,64125 MHz	25	27,84125 MHz
6	27,65125 MHz	26	27,85125 MHz
7	27,66125 MHz	27	27,86125 MHz
8	27,67125 MHz	28	27,87125 MHz
9	27,68125 MHz	29	27,88125 MHz
10	27,69125 MHz	30	27,89125 MHz
11	27,70125 MHz	31	27,90125 MHz
12	27,71125 MHz	32	27,91125 MHz
13	27,72125 MHz	33	27,92125 MHz
14	27,73125 MHz	34	27,93125 MHz
15	27,74125 MHz	35	27,94125 MHz
16	27,75125 MHz	36	27,95125 MHz
17	27,76125 MHz	37	27,96125 MHz
18	27,77125 MHz	38	27,97125 MHz
19	27,78125 MHz	39	27,98125 MHz
20	27,79125 MHz	40	27,99125 MHz

FREQUENCY TABLE for d

Channel	Frequency	Channel	Frequency
1	26,965 MHz	21	27,215 MHz
2	26,975 MHz	22	27,225 MHz
3	26,985 MHz	23	27,255 MHz
4	27,005 MHz	24	27,235 MHz
5	27,015 MHz	25	27,245 MHz
6	27,025 MHz	26	27,265 MHz
7	27,035 MHz	27	27,275 MHz
8	27,055 MHz	28	27,285 MHz
9	27,065 MHz	29	27,295 MHz
10	27,075 MHz	30	27,305 MHz
11	27,085 MHz	31	27,315 MHz
12	27,105 MHz	32	27,325 MHz
13	27,115 MHz	33	27,335 MHz
14	27,125 MHz	34	27,345 MHz
15	27,135 MHz	35	27,355 MHz
16	27,155 MHz	36	27,365 MHz
17	27,165 MHz	37	27,375 MHz
18	27,175 MHz	38	27,385 MHz
19	27,185 MHz	39	27,395 MHz
20	27,205 MHz	40	27,405 MHz

Channel	Frequency	Channel	Frequency
41	26,565 MHz	61	26,765 MHz
42	26,575 MHz	62	26,775 MHz
43	26,585 MHz	63	26,785 MHz
44	26,595 MHz	64	26,795 MHz
45	26,605 MHz	65	26,805 MHz
46	26,615 MHz	66	26,815 MHz
47	26,625 MHz	67	26,825 MHz
48	26,635 MHz	68	26,835 MHz
49	26,645 MHz	69	26,845 MHz
50	26,655 MHz	70	26,855 MHz
51	26,665 MHz	71	26,865 MHz
52	26,675 MHz	72	26,875 MHz
53	26,685 MHz	73	26,885 MHz
54	26,695 MHz	74	26,895 MHz
55	26,705 MHz	75	26,905 MHz
56	26,715 MHz	76	26,915 MHz
57	26,725 MHz	77	26,925 MHz
58	26,735 MHz	78	26,935 MHz
59	26,745 MHz	79	26,945 MHz
60	26,755 MHz	80	26,955 MHz

FREQUENCY TABLE for PL

Channel	Frequency	Channel	Frequency
1	26,960 MHz	21	27,210 MHz
2	26,970 MHz	22	27,220 MHz
3	26,980 MHz	23	27,250 MHz
4	27,000 MHz	24	27,230 MHz
5	27,010 MHz	25	27,240 MHz
6	27,020 MHz	26	27,260 MHz
7	27,030 MHz	27	27,270 MHz
8	27,050 MHz	28	27,280 MHz
9	27,060 MHz	29	27,290 MHz
10	27,070 MHz	30	27,300 MHz
11	27,080 MHz	31	27,310 MHz
12	27,100 MHz	32	27,320 MHz
13	27,110 MHz	33	27,330 MHz
14	27,120 MHz	34	27,340 MHz
15	27,130 MHz	35	27,350 MHz
16	27,150 MHz	36	27,360 MHz
17	27,160 MHz	37	27,370 MHz
18	27,170 MHz	38	27,380 MHz
19	27,180 MHz	39	27,390 MHz
20	27,200 MHz	40	27,400 MHz

FREQUENCY TABLE for In

Channel	Frequency	Channel	Frequency
1	26,965 MHz	21	27,215 MHz
2	26,975 MHz	22	27,225 MHz
3	26,985 MHz	23	27,255 MHz
4	27,005 MHz	24	27,235 MHz
5	27,015 MHz	25	27,245 MHz
6	27,025 MHz	26	27,265 MHz
7	27,035 MHz	27	27,275 MHz
8	27,055 MHz		
9	27,065 MHz		
10	27,075 MHz		
11	27,085 MHz		
12	27,105 MHz		
13	27,115 MHz		
14	27,125 MHz		
15	27,135 MHz		
16	27,155 MHz		
17	27,165 MHz		
18	27,175 MHz		
19	27,185 MHz		
20	27,205 MHz		

THOMAS RJ45 MICROPHONE PLUG

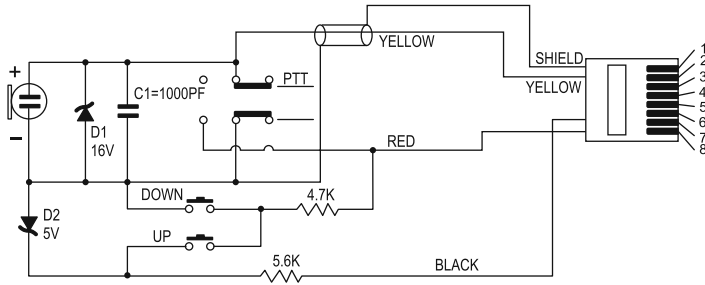

- 1 - SHIELD
- 2 - YELLOW
- 3 - NC
- 4 - NC
- 5 - NC
- 6 - BLACK
- 7 - NC
- 8 - RED

CTCSS Tone List

No.	Freq. (Hz)	No.	Freq. (Hz)	No.	Freq. (Hz)
00 - μF	OFF	13	103.5	26	162.2
01	67.0	14	107.2	27	167.9
02	71.9	15	110.9	28	173.8
03	74.4	16	114.8	29	179.9
04	77.0	17	118.8	30	186.2
05	79.7	18	123.0	31	192.8
06	82.5	19	127.3	32	203.5
07	85.4	20	131.8	33	210.7
08	88.5	21	136.5	34	218.1
09	91.5	22	141.3	35	225.7
10	94.8	23	146.2	36	233.6
11	97.4	24	151.4	37	241.8
12	100.0	25	156.7	38	250.3

DCS Code List

Code No.	DCS (Octal)	Code No.	DCS (Octal)	Code No.	DCS (Octal)	Code No.	DCS (Octal)
1	023	27	152	53	311	79	466
2	025	28	155	54	315	80	503
3	026	29	156	55	325	81	506
4	031	30	162	56	331	82	516
5	032	31	165	57	332	83	523
6	036	32	172	58	343	84	526
7	043	33	174	59	346	85	532
8	047	34	205	60	351	86	546
9	051	35	212	61	356	87	565
10	053	36	223	62	364	88	606
11	054	37	225	63	365	89	612
12	065	38	226	64	371	90	624
13	071	39	243	65	411	91	627
14	072	40	244	66	412	92	631
15	073	41	245	67	413	93	632
16	074	42	246	68	423	94	654
17	114	43	251	69	431	95	662
18	115	44	252	70	432	96	664
19	116	45	255	71	445	97	703
20	122	46	261	72	446	98	712
21	125	47	263	73	452	99	723
22	131	48	265	74	454	100	731
23	132	49	266	75	455	101	732
24	134	50	271	76	462	102	734
25	143	51	274	77	464	103	743
26	145	52	306	78	465	104	754

Nº	Configuration Code	FM Channel	AM Channel	Country
1	EU	40 Ch (4W)	40 Ch (4W)	BE, BG, CH, CY, CZ, DK, EE, ES, FI, FR, GR, IE, IS, IT, LT, LU, LV, NL, NO, PT, RO, SE, SI
2	PL	-5 KHz 40 Ch (4W)	-5 KHz 40 Ch (4W)	PL
3	d	80 Ch (4W)	40 Ch (4W)	DE
4	EC	40 Ch (4W)	-	AT, HU, MT, SK
5	U	CEPT 40 Ch (4W) + ENG 40 Ch (4W)	-	GB
6	In	27 Ch (4W)	27 Ch (4W)	IN

The frequency band and the transmission power of your transceiver must correspond with the configuration authorized in the country where it is used.

*Note: In **U** configuration : In order to select the frequency band **ENG/CEPT**. Push the AM/FM key **(6)**. When the frequency band is **ENG**, "**UK**" appears on the display. When the frequency band is **CEPT** "**UK**" disappears from the display.*

Countries in which there are particular restrictions (Licence¹ / Register²)

	AT	BE	BG	CH	CY	CZ	DE	DK	EE	ES	FI	FR	GB	GR	HU	IE	IS	IT	LT	LU	LV	MT	NL	NO	PL	PT	RO	SE	SI	SK	
Licence ¹	⚠			⚠									⚠	⚠				⚠				⚠									
Register ²										⚠																⚠					
AM	⚠												⚠		⚠							⚠									⚠
BLU / SSB	⚠												⚠		⚠							⚠									⚠

Please see updated table on website www.president-electronics.com, page «The CB radios» then «President Radio CB and Europe».

Groupe
PRESIDENT
ELECTRONICS

SIEGE SOCIAL/HEAD OFFICE - FRANCE
Route de Sète - BP 100 - 34540 BALARUC
Site Internet : <http://www.president-electronics.com>
E-mail : groupe@president-electronics.com



CE 0341 ! U01UT391ZZC(0)

1251/03-12/02-13

PRESIDENT